

NCP4625

300 mA, 10 V, Low Dropout Regulator

The NCP4625 is a CMOS Linear voltage regulator with 300 mA output current capability. The device is capable of operating with input voltages up to 10 V, with high output voltage accuracy and low temperature–drift coefficient. The NCP4625 is easy to use, with output current fold–back protection and a thermal shutdown circuit included. A Chip Enable function is included to save power by lowering supply current.

Features

- Operating Input Voltage Range: 2.6 V to 10 V
- Output Voltage Range: 1.2 to 6.0 V (available in 0.1 V steps)
- Low Supply Current: 23 μ A
- Very Low Dropout:
 - ◆ 200 mV ($I_{OUT} = 100$ mA, $V_{IN} = 3.0$ V)
 - ◆ 770 mV ($I_{OUT} = 300$ mA, $V_{IN} = 2.8$ V)
- High PSRR: 70 dB at 1 kHz
- Line Regulation 0.02%/V Typ
- Current Fold Back Protection
- Thermal Shutdown Protection
- Stable with Ceramic Capacitors
- Available in SC–70, SOT89 and SOT–23 Package
- These are Pb–Free Devices

Typical Applications

- Battery products powered by Two Lithium Ion cells
- Networking and Communication Equipment
- Cameras, DVRs, STB and Camcorders
- Toys, industrial applications

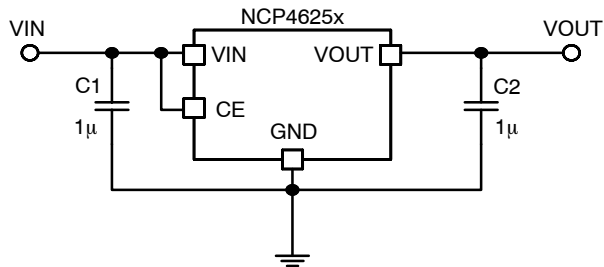

Figure 1. Typical Application Schematic



ON Semiconductor™

<http://onsemi.com>

MARKING DIAGRAMS



SC–70
CASE 419A

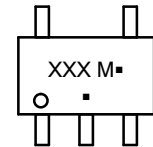

SOT–89 5
CASE 528AB

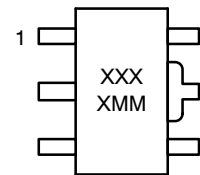

SOT–23–5
CASE 1212

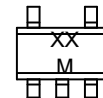

XX, XXX= Specific Device Code
M, MM = Date Code
A = Assembly Location
Y = Year
W = Work Week
▪ = Pb–Free Package

(Note: Microdot may be in either location)

ORDERING INFORMATION

See detailed ordering and shipping information in the package dimensions section on page 14 of this data sheet.

NCP4625

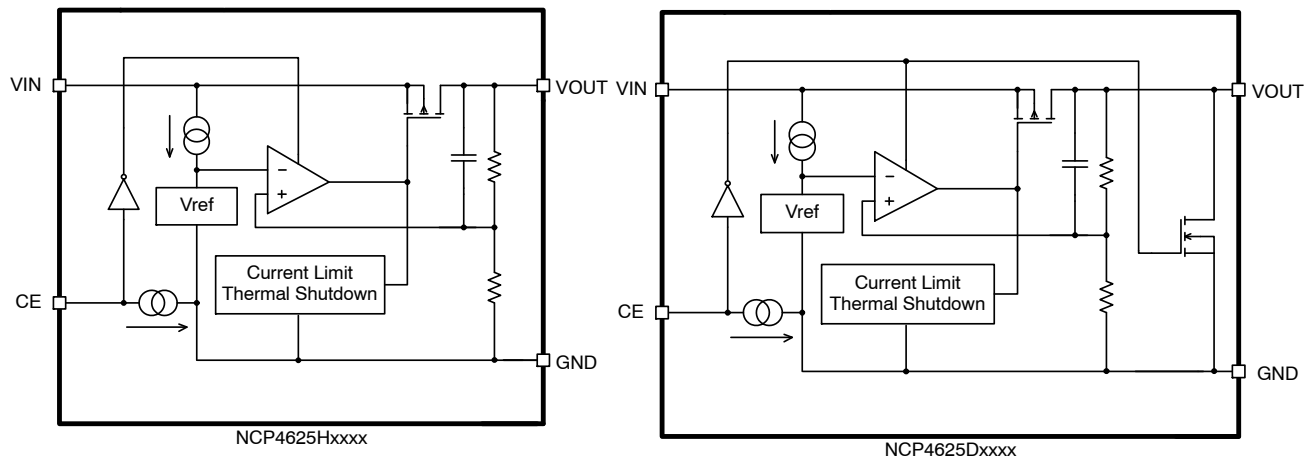

Figure 2. Simplified Schematic Block Diagram

PIN FUNCTION DESCRIPTION

| Pin No. SOT89 | Pin No. SC-70 | Pin No. SOT23 | Pin Name | Description |
|---------------|---------------|---------------|----------|------------------------------|
| 5 | 5 | 1 | VIN | Input pin |
| 2 | 3 | 2 | GND | Ground |
| 3 | 1 | 3 | CE | Chip enable pin (Active "H") |
| 1 | 4 | 5 | VOUT | Output pin |
| 4 | 2 | 4 | NC | No connection |

ABSOLUTE MAXIMUM RATINGS

| Rating | Symbol | Value | Unit |
|---|-------------|------------------------|------|
| Input Voltage (Note 1) | V_{IN} | 12.0 | V |
| Output Voltage | V_{OUT} | -0.3 to $V_{IN} + 0.3$ | V |
| Chip Enable Input | V_{CE} | 12.0 | V |
| Output Current | I_{OUT} | 330 | mA |
| Power Dissipation SOT89 | P_D | 900 | mW |
| Power Dissipation SC-70 | | 380 | |
| Power Dissipation SOT23 | | 420 | |
| Junction Temperature | T_J | -40 to 150 | °C |
| Storage Temperature | T_{STG} | -55 to 125 | °C |
| ESD Capability, Human Body Model (Note 2) | ESD_{HBM} | 2000 | V |
| ESD Capability, Machine Model (Note 2) | ESD_{MM} | 200 | V |

Stresses exceeding Maximum Ratings may damage the device. Maximum Ratings are stress ratings only. Functional operation above the Recommended Operating Conditions is not implied. Extended exposure to stresses above the Recommended Operating Conditions may affect device reliability.

1. Refer to ELECTRICAL CHARACTERISTICS and APPLICATION INFORMATION for Safe Operating Area.
2. This device series incorporates ESD protection and is tested by the following methods:
 ESD Human Body Model tested per AEC-Q100-002 (EIA/JESD22-A114)
 ESD Machine Model tested per AEC-Q100-003 (EIA/JESD22-A115)
 Latchup Current Maximum Rating tested per JEDEC standard: JESD78.

NCP4625

THERMAL CHARACTERISTICS

| Rating | Symbol | Value | Unit |
|---|-----------------|-------|-----------------------------|
| Thermal Characteristics, SOT89 Thermal Resistance, Junction-to-Air | $R_{\theta JA}$ | 111 | $^{\circ}\text{C}/\text{W}$ |
| Thermal Characteristics, SOT23 Thermal Resistance, Junction-to-Air | $R_{\theta JA}$ | 238 | $^{\circ}\text{C}/\text{W}$ |
| Thermal Characteristics, SC-70 Thermal Resistance, Junction-to-Air | $R_{\theta JA}$ | 263 | $^{\circ}\text{C}/\text{W}$ |

ELECTRICAL CHARACTERISTICS $-40^{\circ}\text{C} \leq T_A \leq 85^{\circ}\text{C}$; $V_{IN} = V_{OUT(NOM)} + 1\text{ V}$; $I_{OUT} = 1\text{ mA}$, $C_{IN} = C_{OUT} = 0.47\text{ }\mu\text{F}$, unless otherwise noted. Typical values are at $T_A = +25^{\circ}\text{C}$.

| Parameter | Test Conditions | Symbol | Min | Typ | Max | Unit |
|--|--|--------------------------|-----------|-----------------------------|--------|-------------------------|
| Operating Input Voltage | | V_{IN} | 2.6 | | 10 | V |
| Output Voltage | $T_A = +25^{\circ}\text{C}$ | $V_{OUT} > 1.5\text{ V}$ | V_{OUT} | x0.99 | x1.01 | V |
| | | | | $V_{OUT} \leq 1.5\text{ V}$ | -15 | 15 |
| | $-40^{\circ}\text{C} \leq T_A \leq 85^{\circ}\text{C}$ | $V_{OUT} > 1.5\text{ V}$ | V_{OUT} | x0.974 | x1.023 | V |
| | | | | $V_{OUT} \leq 1.5\text{ V}$ | -40 | 35 |
| Output Voltage Temp. Coefficient | $-40^{\circ}\text{C} \leq T_A \leq 85^{\circ}\text{C}$ | | | ± 80 | | ppm/ $^{\circ}\text{C}$ |
| Line Regulation | $V_{OUT(NOM)} + 0.5\text{ V}$ or 2.6 V (whichever is higher) $\leq V_{IN} \leq 10\text{ V}$ | LineReg | | 0.02 | 0.2 | %/V |
| Load Regulation | $I_{OUT} = 0.1\text{ mA}$ to 300 mA | LineReg | | 10 | 70 | mV |
| Dropout Voltage | $I_{OUT} = 300\text{ mA}$ | V_{DO} | | 1.40 | 1.80 | V |
| | | | | 1.35 | 1.75 | |
| | | | | 1.20 | 1.55 | |
| | | | | 0.98 | 1.30 | |
| | | | | 0.77 | 1.08 | |
| | | | | 0.60 | 0.85 | |
| | | | | 0.50 | 0.75 | |
| Output Current | | I_{OUT} | 300 | | | mA |
| Short Current Limit | $V_{OUT} = 0\text{ V}$ | I_{SC} | | 40 | | mA |
| Quiescent Current | | I_Q | | 23 | 40 | μA |
| Standby Current | $V_{IN} = 10\text{ V}$, $V_{CE} = 0\text{ V}$, $T_A = 25^{\circ}\text{C}$ | I_{STB} | | 0.1 | 1.0 | μA |
| CE Pin Threshold Voltage | CE Input Voltage "H" | V_{CEH} | 1.7 | | | V |
| | CE Input Voltage "L" | V_{CEL} | | | 0.8 | |
| CE Pull Down Current | | I_{CEPD} | | 0.3 | | μA |
| Power Supply Rejection Ratio | $V_{IN} = V_{OUT} + 1\text{ V}$ or 3.0 V whichever is higher, $\Delta V_{IN} = 0.2\text{ V}_{pk-pk}$, $I_{OUT} = 30\text{ mA}$, $f = 1\text{ kHz}$ | PSRR | | 70 | | dB |
| Output Noise Voltage | $f = 10\text{ Hz}$ to 100 kHz | V_N | | 85 | | μV_{rms} |
| Low Output N-channel Tr. On Resistance | $V_{IN} = 7\text{ V}$, $V_{CE} = 0\text{ V}$, $V_{OUT} = 1.2\text{ V}$, $V_{IN} = 2.6\text{ V}$, $I_{OUT} = 30\text{ mA}$ | R_{LOW} | | 250 | | Ω |
| Thermal Shutdown Temperature | | T_{TSD} | | 165 | | $^{\circ}\text{C}$ |
| Thermal Shutdown Release | | T_{TSR} | | 110 | | $^{\circ}\text{C}$ |

TYPICAL CHARACTERISTICS

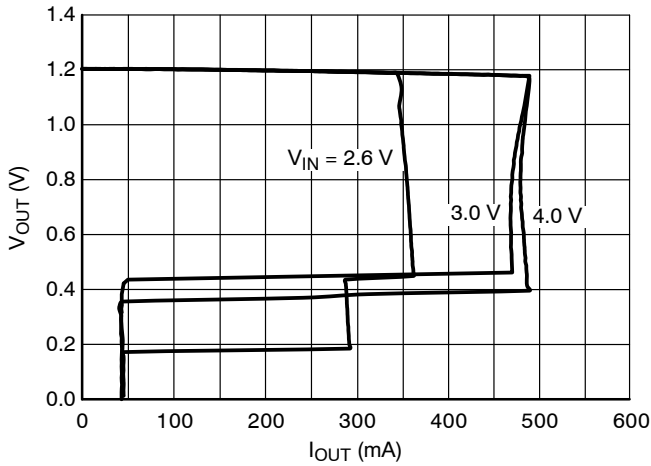

Figure 3. Output Voltage vs. Output Current
1.2 V Version ($T_J = 25^\circ\text{C}$)

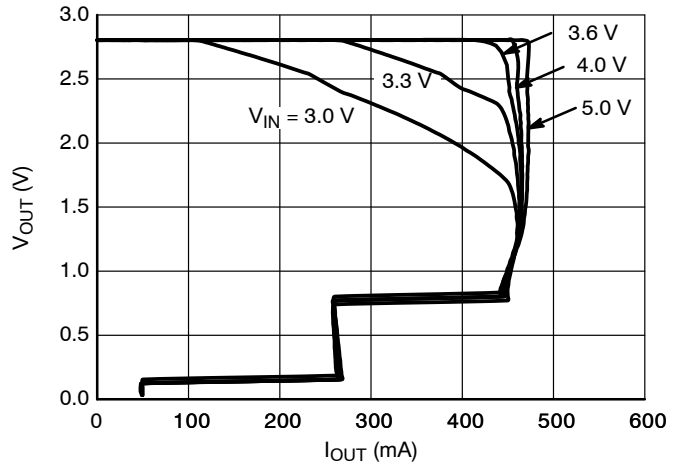

Figure 4. Output Voltage vs. Output Current
2.8 V Version ($T_J = 25^\circ\text{C}$)

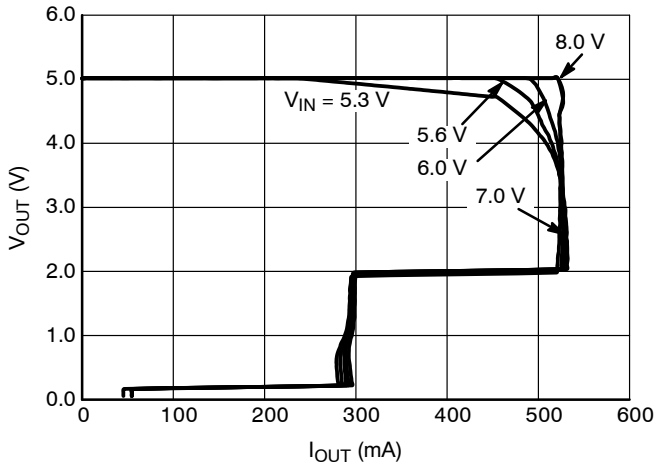

Figure 5. Output Voltage vs. Output Current
5.0 V Version ($T_J = 25^\circ\text{C}$)

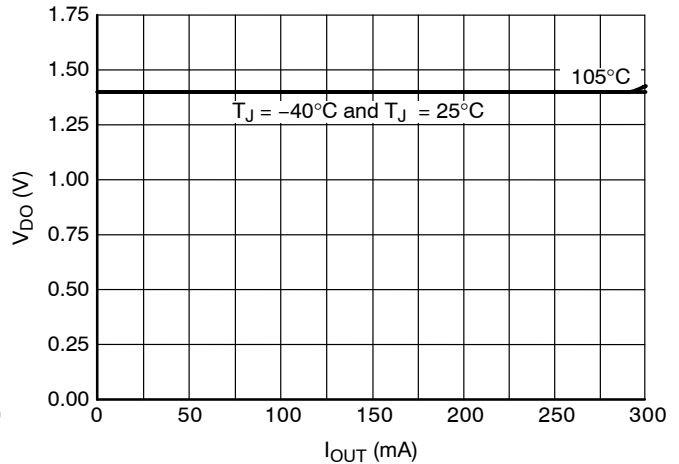

Figure 6. Dropout Voltage vs. Output Current
1.2 V Version

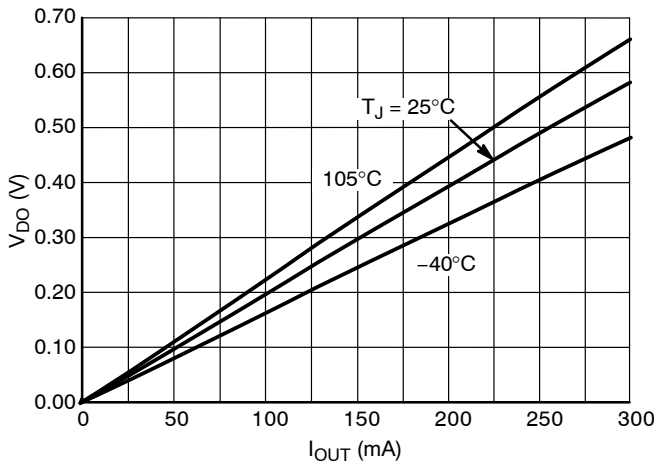

Figure 7. Dropout Voltage vs. Output Current
2.8 V Version

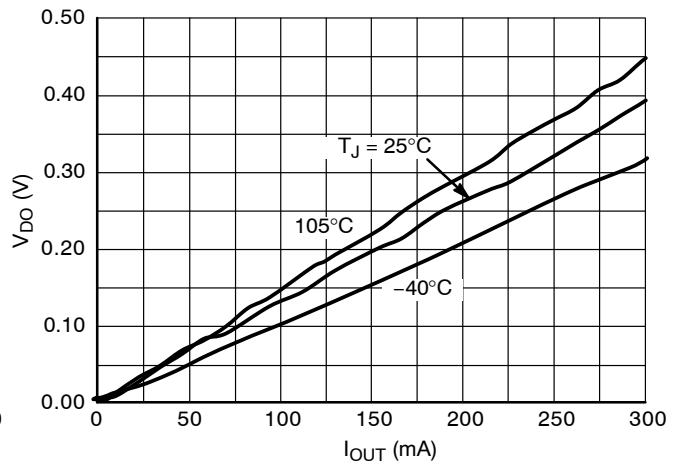

Figure 8. Dropout Voltage vs. Output Current
5.0 V Version

TYPICAL CHARACTERISTICS

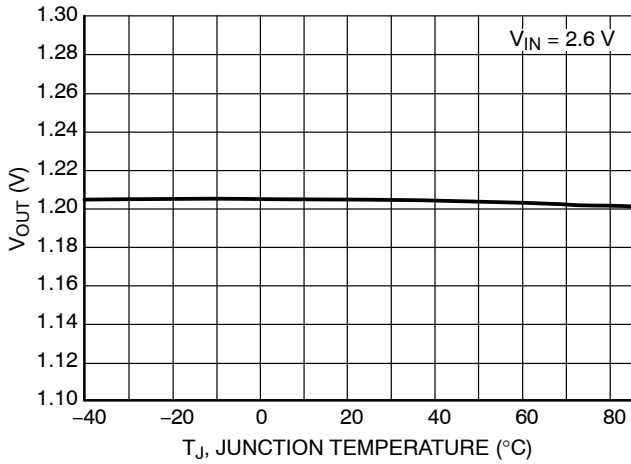

Figure 9. Output Voltage vs. Temperature, 1.2 V Version

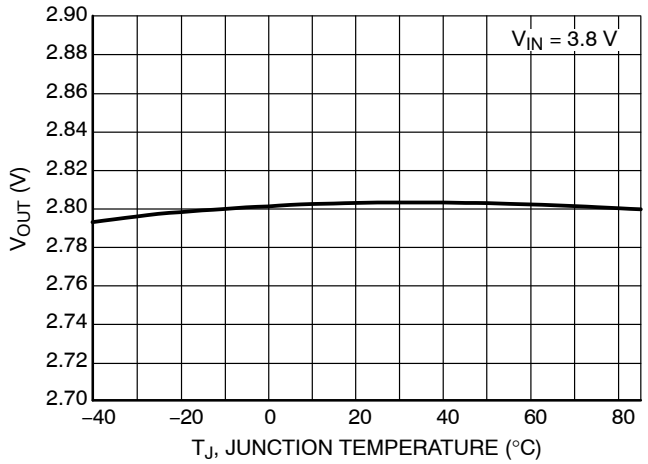

Figure 10. Output Voltage vs. Temperature, 2.8 V Version

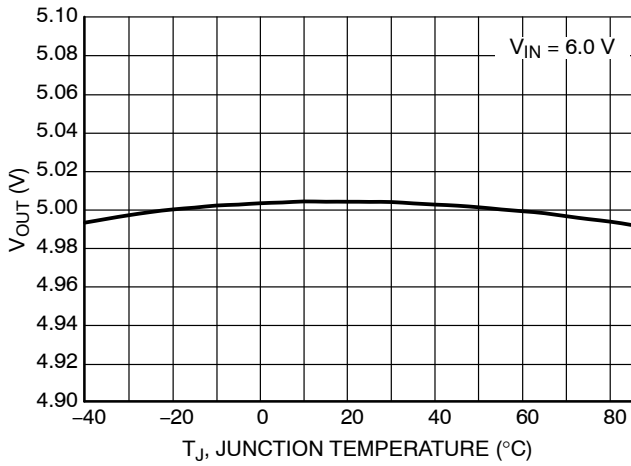

Figure 11. Output Voltage vs. Temperature, 5.0 V Version

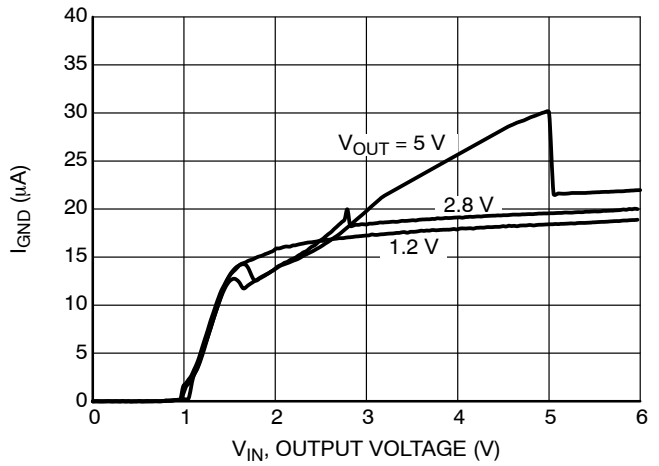

Figure 12. Supply Current vs. Input Voltage

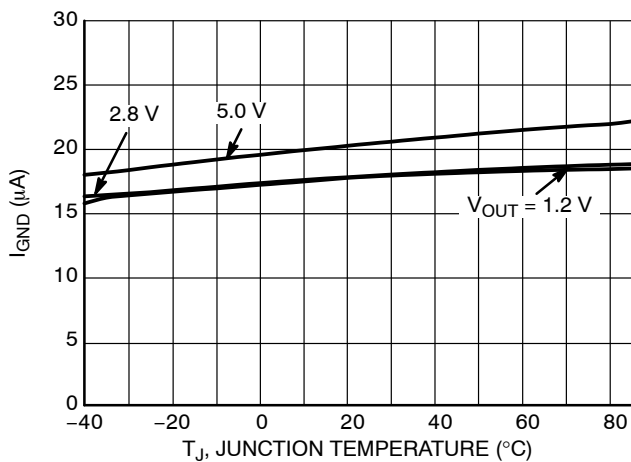

Figure 13. Supply Current vs. Temperature, 1.2 V Version

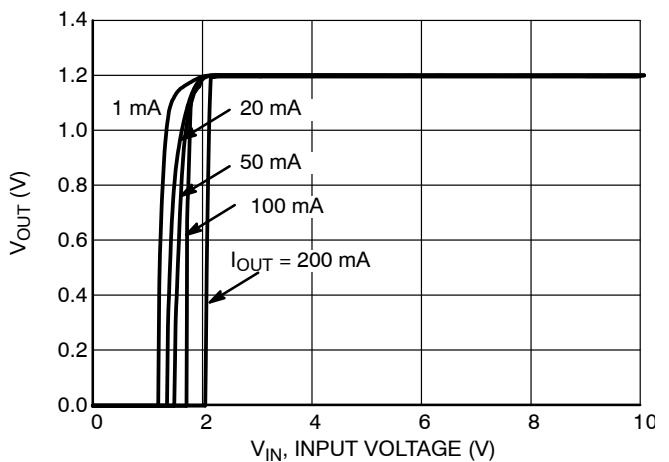

Figure 14. Output Voltage vs. Input Voltage, 1.2 V Version

TYPICAL CHARACTERISTICS

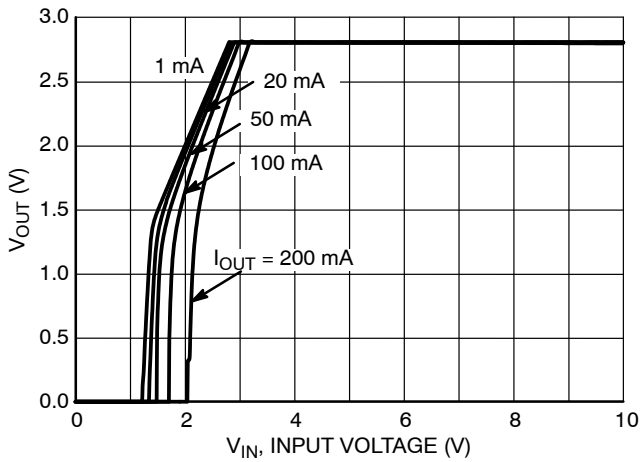

Figure 15. Output Voltage vs. Input Voltage, 2.8 V Version

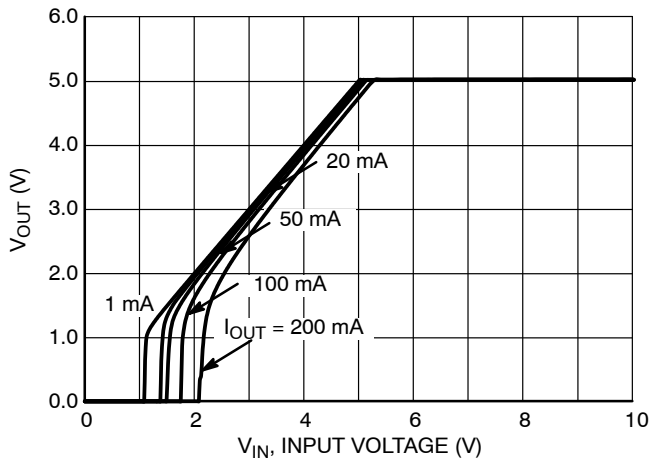

Figure 16. Output Voltage vs. Input Voltage, 5.0 V Version

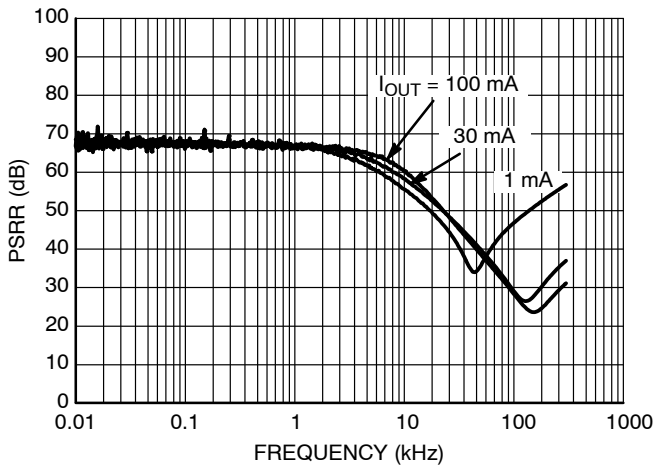

Figure 17. PSRR, 1.2 V Version, $V_{IN} = 2.6 V$

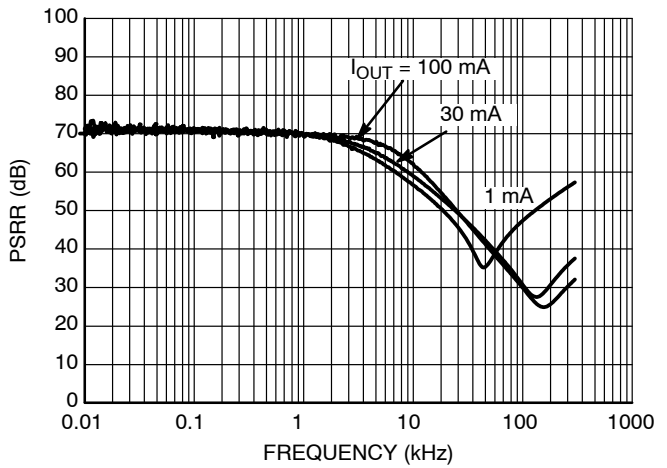

Figure 18. PSRR, 1.2 V Version, $V_{IN} = 3.0 V$

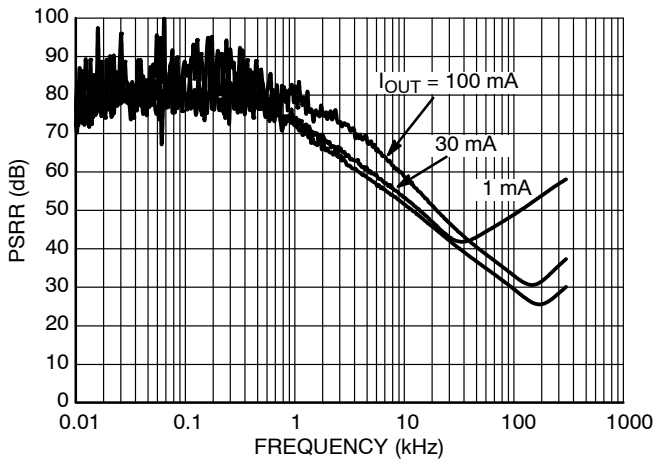

Figure 19. PSRR, 2.8 V Version, $V_{IN} = 3.8 V$

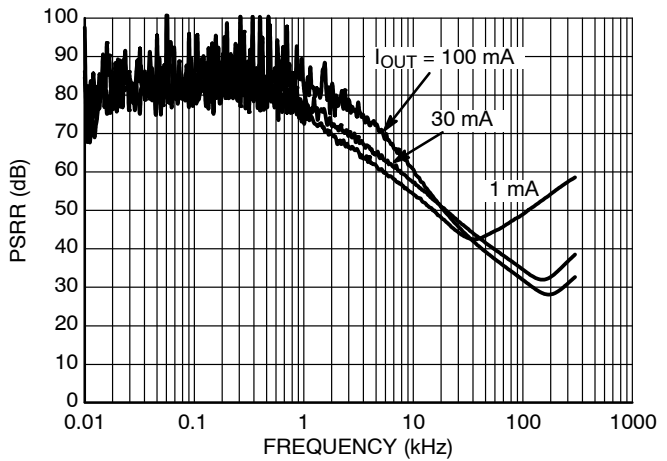

Figure 20. PSRR, 2.8 V Version, $V_{IN} = 4.8 V$

TYPICAL CHARACTERISTICS

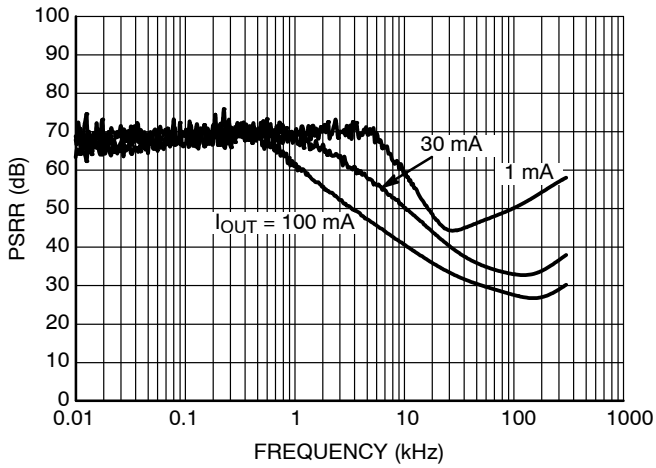

Figure 21. PSRR, 5.0 V Version, $V_{IN} = 6.0 V$

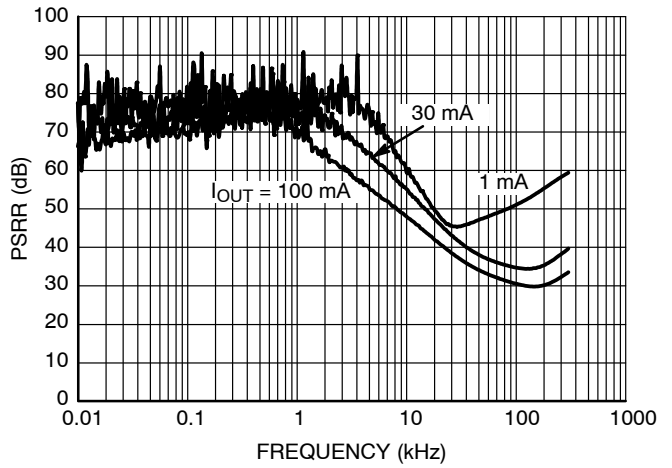

Figure 22. PSRR, 5.0 V Version, $V_{IN} = 7.0 V$

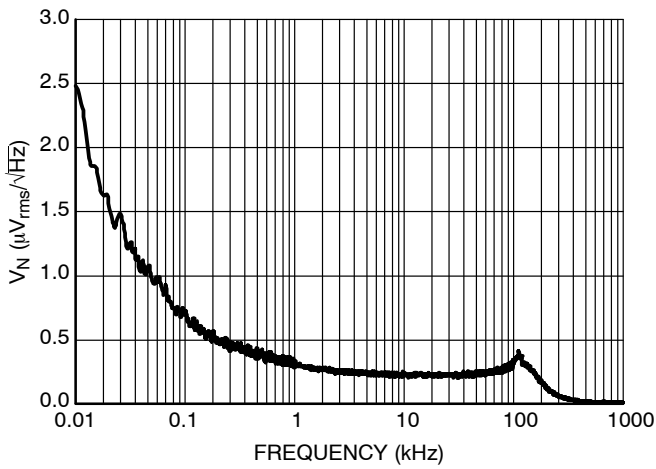

Figure 23. Output Voltage Noise, 1.2 V Version, $V_{IN} = 2.6 V$

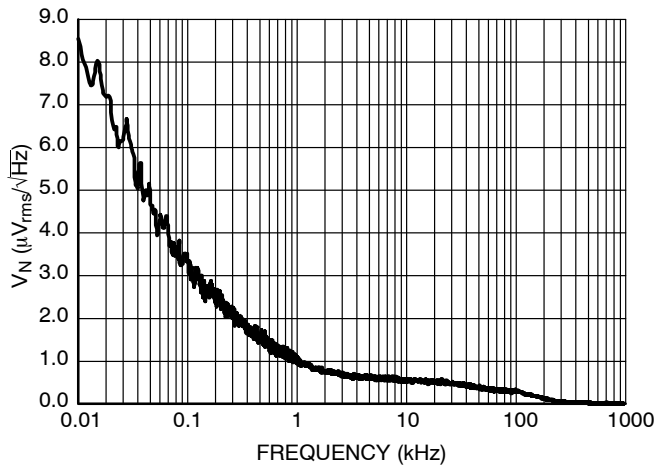

Figure 24. Output Voltage Noise, 2.8 V Version, $V_{IN} = 3.8 V$

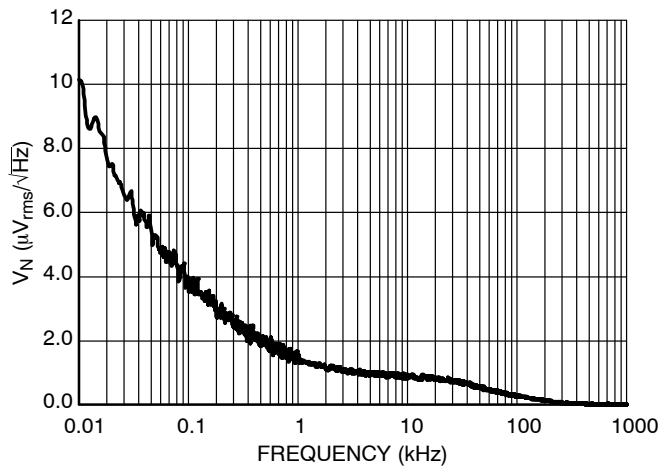
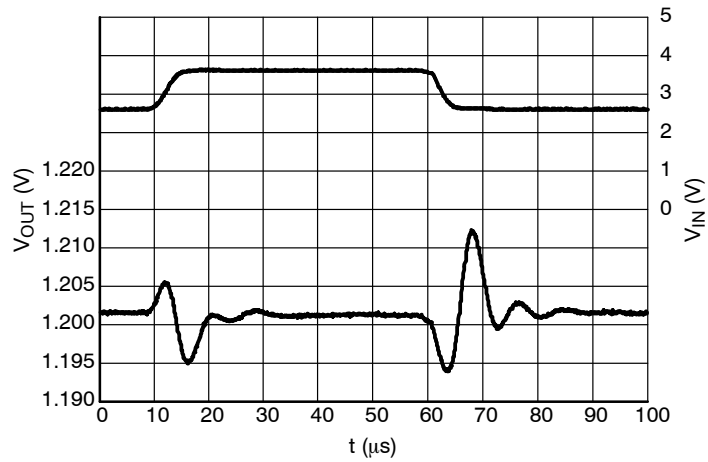

Figure 25. Output Voltage Noise, 5.0 V Version, $V_{IN} = 6.0 V$

NCP4625

TYPICAL CHARACTERISTICS



**Figure 26. Line Transients, 1.2 V Version,
 $t_R = t_F = 5 \mu s$, $I_{OUT} = 30 \text{ mA}$**

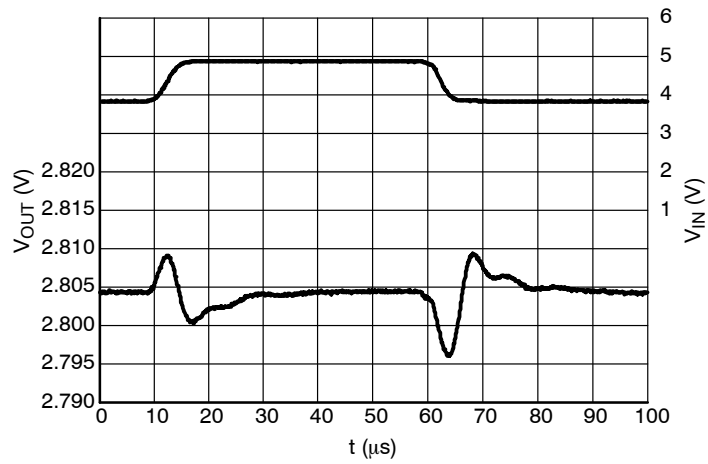

**Figure 27. Line Transients, 2.8 V Version,
 $t_R = t_F = 5 \mu s$, $I_{OUT} = 30 \text{ mA}$**

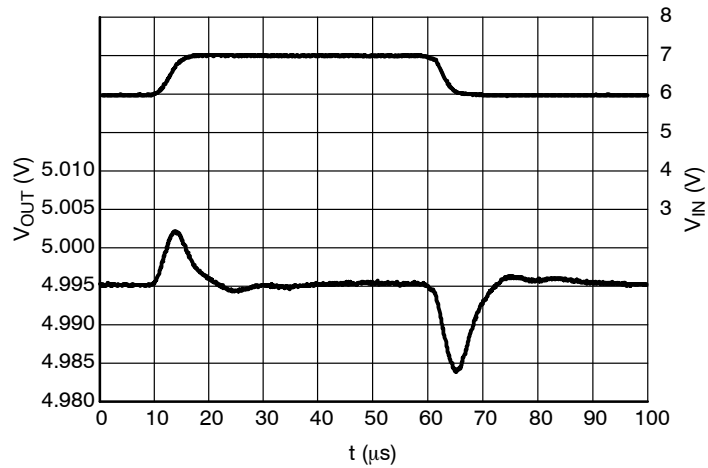

**Figure 28. Line Transients, 5.0 V Version,
 $t_R = t_F = 5 \mu s$, $I_{OUT} = 30 \text{ mA}$**

NCP4625

TYPICAL CHARACTERISTICS

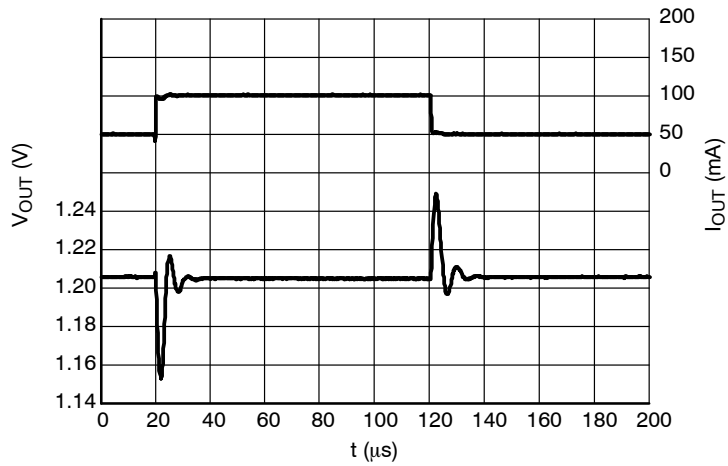

**Figure 29. Load Transients, 1.2 V Version,
 $I_{OUT} = 50 - 100 \text{ mA}$, $t_R = t_F = 0.5 \mu\text{s}$, $V_{IN} = 2.6 \text{ V}$**

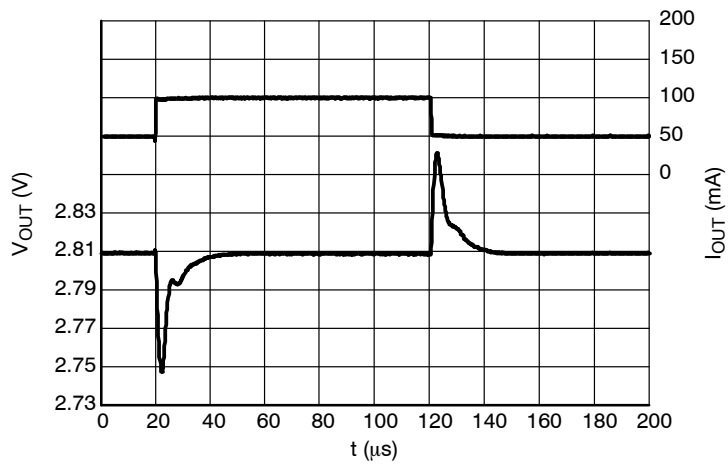

**Figure 30. Load Transients, 2.8 V Version,
 $I_{OUT} = 50 - 100 \text{ mA}$, $t_R = t_F = 0.5 \mu\text{s}$, $V_{IN} = 3.8 \text{ V}$**

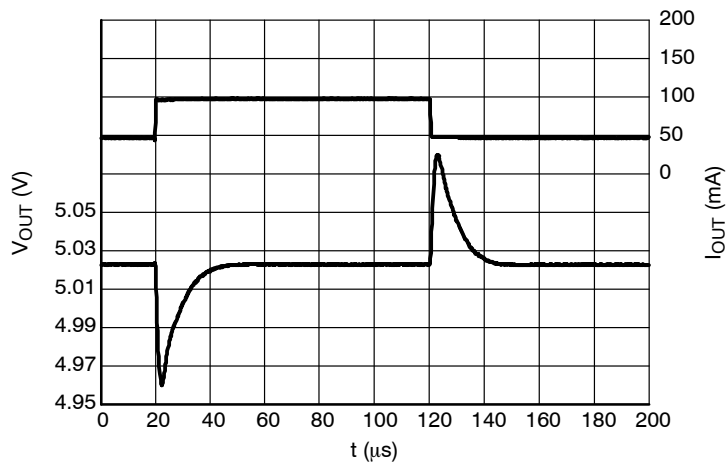

**Figure 31. Load Transients, 5.0 V Version,
 $I_{OUT} = 50 - 100 \text{ mA}$, $t_R = t_F = 0.5 \mu\text{s}$, $V_{IN} = 6.0 \text{ V}$**

NCP4625

TYPICAL CHARACTERISTICS

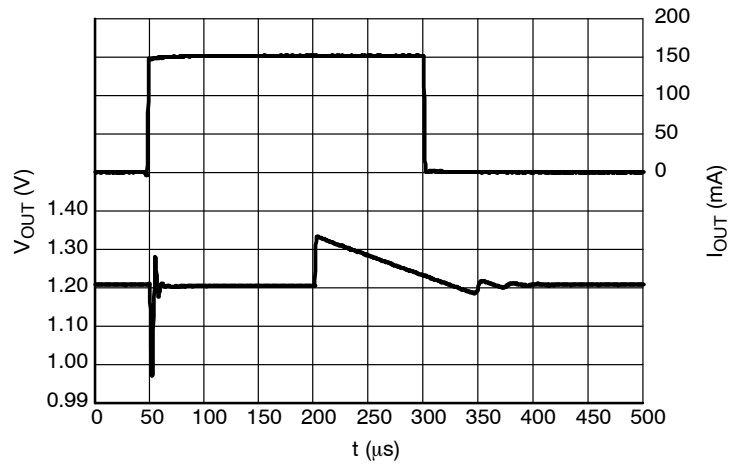

**Figure 32. Load Transients, 1.2 V Version,
 $I_{OUT} = 1 - 150 \text{ mA}$, $t_R = t_F = 0.5 \mu\text{s}$, $V_{IN} = 2.6 \text{ V}$**

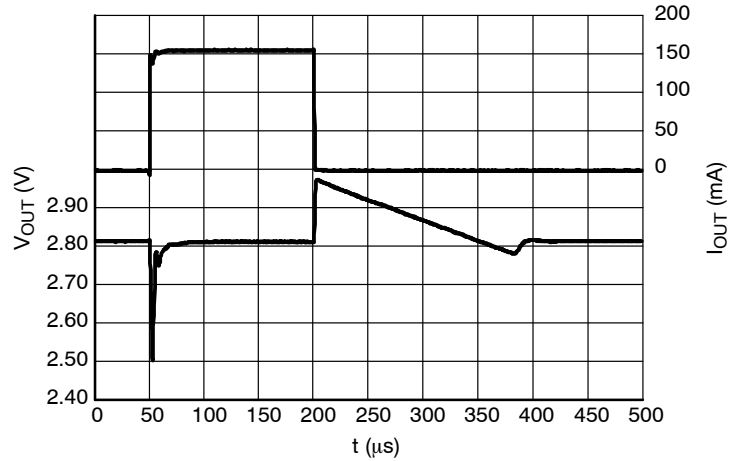

**Figure 33. Load Transients, 2.8 V Version,
 $I_{OUT} = 1 - 150 \text{ mA}$, $t_R = t_F = 0.5 \mu\text{s}$, $V_{IN} = 3.8 \text{ V}$**

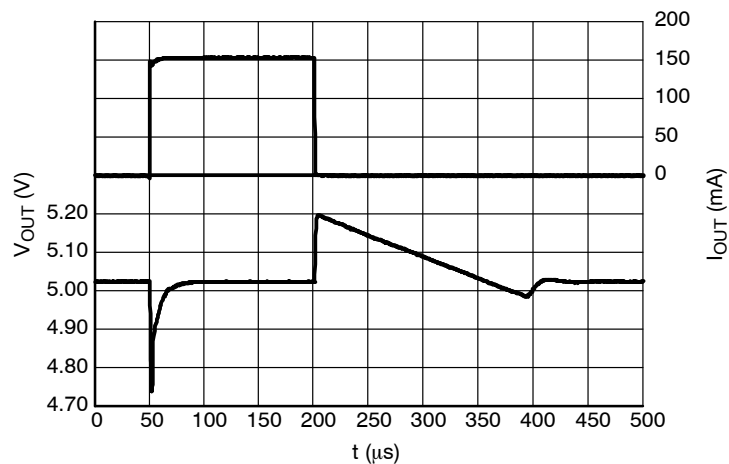

**Figure 34. Load Transients, 5.0 V Version,
 $I_{OUT} = 1 - 150 \text{ mA}$, $t_R = t_F = 0.5 \mu\text{s}$, $V_{IN} = 6.0 \text{ V}$**

NCP4625

TYPICAL CHARACTERISTICS

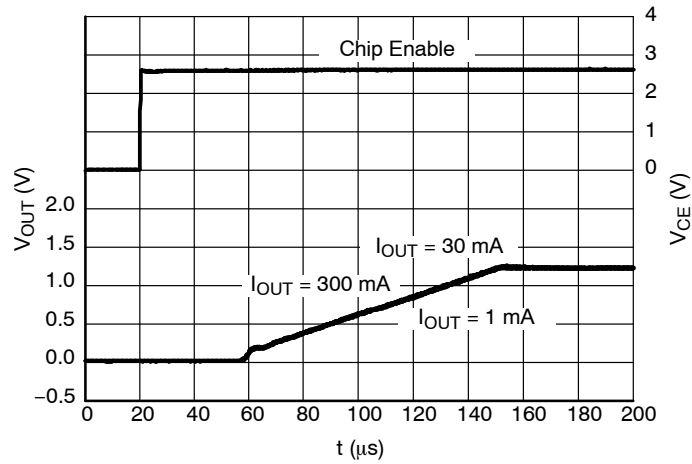

Figure 35. Start-up, 1.2 V Version, $V_{IN} = 2.6$ V

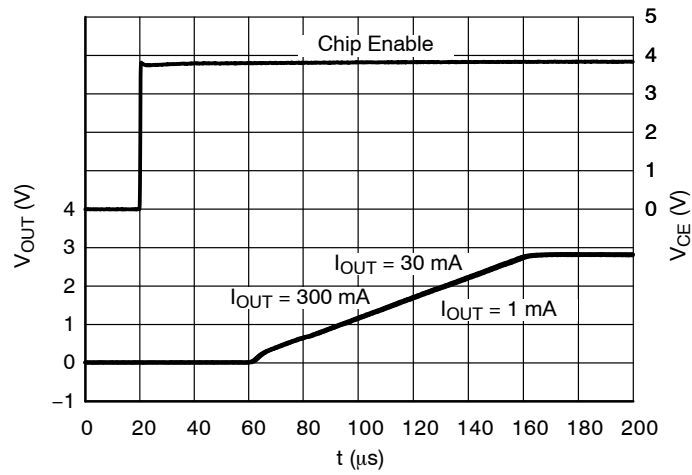

Figure 36. Start-up, 2.8 V Version, $V_{IN} = 3.8$ V

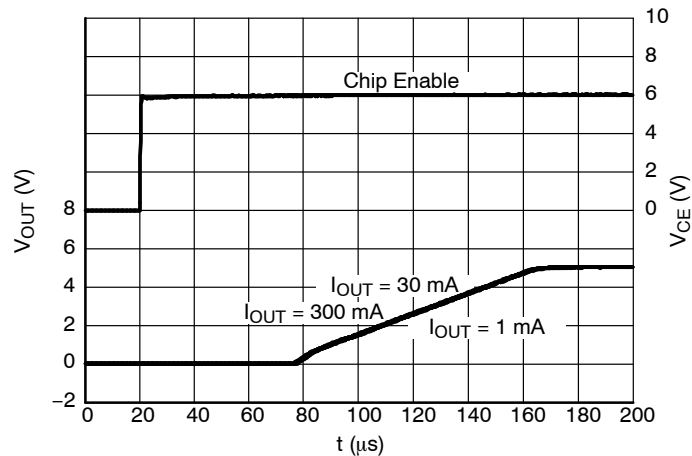

Figure 37. Start-up, 5.0 V Version, $V_{IN} = 6.0$ V

NCP4625

TYPICAL CHARACTERISTICS

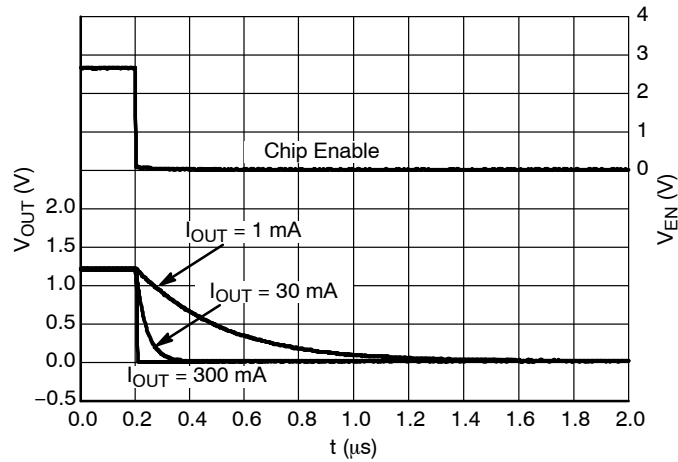

Figure 38. Shutdown, 1.2 V Version D,
 $V_{IN} = 2.6 \text{ V}$

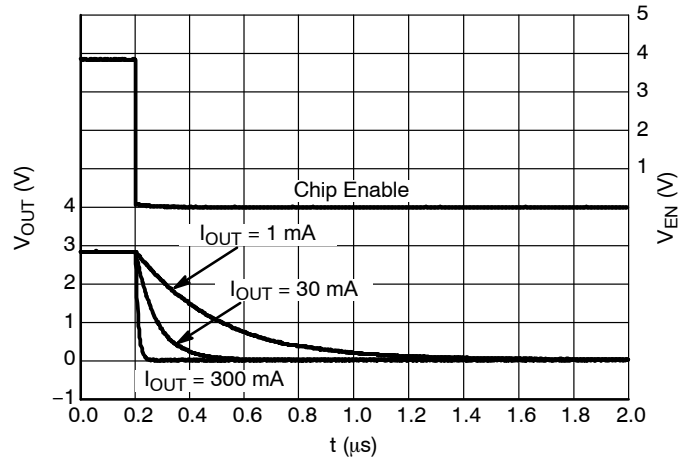

Figure 39. Shutdown, 2.8 V Version D,
 $V_{IN} = 3.8 \text{ V}$

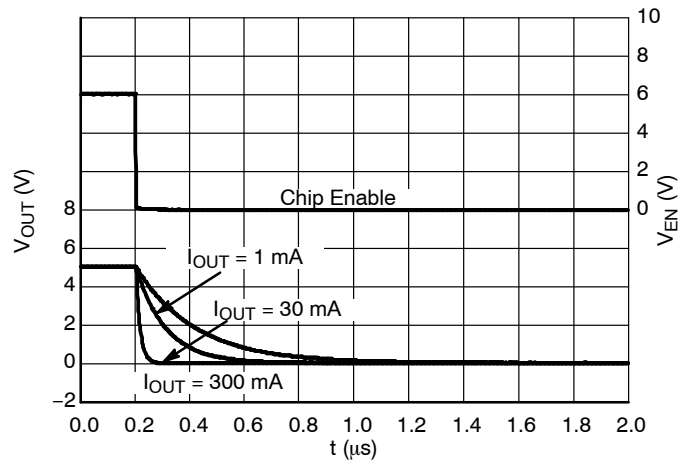

Figure 40. Shutdown, 5.0 V Version D,
 $V_{IN} = 6.0 \text{ V}$

APPLICATION INFORMATION

A typical application circuit for NCP4625 series is shown in Figure 41.

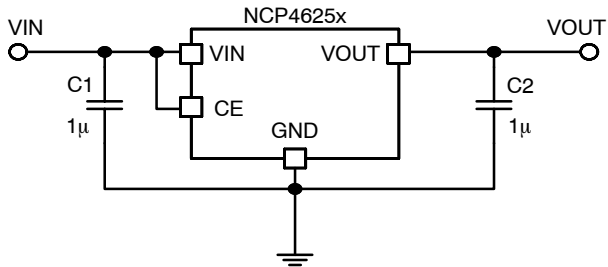

Figure 41. Typical Application Schematic

Input Decoupling Capacitor (C1)

A 1 μF ceramic input decoupling capacitor should be connected as close as possible to the input and ground pin of the NCP4625. Higher values and lower ESR improves line transient response.

Output Decoupling Capacitor (C2)

A 1 μF ceramic output decoupling capacitor is enough to achieve stable operation of the IC. If a tantalum capacitor is used, and its ESR is high, loop oscillation may result. The capacitors should be connected as close as possible to the output and ground pins. Larger values and lower ESR improves dynamic parameters.

Enable Operation

The enable pin CE may be used for turning the regulator on and off. The IC is switched on when a high level voltage is applied to the CE pin. The enable pin has an internal pull down current source. If the enable function is not needed connect CE pin to VIN.

Output Discharger

The D version includes a transistor between V_{OUT} and GND that is used for faster discharging of the output capacitor. This function is activated when the IC goes into disable mode.

Thermal

As a power across the IC increase, it might become necessary to provide some thermal relief. The maximum power dissipation supported by the device is dependent upon board design and layout. Mounting pad configuration on the PCB, the board material, and also the ambient temperature affect the rate of temperature increase for the part. When the device has good thermal conductivity through the PCB the junction temperature will be relatively low in high power dissipation applications.

PCB Layout

Make the VIN and GND line as large as practical. If their impedance is high, noise pickup or unstable operation may result. Connect capacitors C1 and C2 as close as possible to the IC, and make wiring as short as possible.

NCP4625

ORDERING INFORMATION

| Device | Nominal Output Voltage | Description | Marking | Package | Shipping [†] |
|-----------------|------------------------|----------------|---------|------------------|-----------------------|
| NCP4625DSN12T1G | 1.2 V | Auto discharge | FBA | SOT-23 (Pb-Free) | 3000 / Tape & Reel |
| NCP4625DSN18T1G | 1.8 V | Auto discharge | FBH | SOT-23 (Pb-Free) | 3000 / Tape & Reel |
| NCP4625DSN28T1G | 2.8 V | Auto discharge | FBU | SOT-23 (Pb-Free) | 3000 / Tape & Reel |
| NCP4625DSN30T1G | 3.0 V | Auto discharge | FBX | SOT-23 (Pb-Free) | 3000 / Tape & Reel |
| NCP4625DSN33T1G | 3.3 V | Auto discharge | GBA | SOT-23 (Pb-Free) | 3000 / Tape & Reel |
| NCP4625DSN50T1G | 5.0 V | Auto discharge | GBT | SOT-23 (Pb-Free) | 3000 / Tape & Reel |
| NCP4625HSN12T1G | 1.2 V | Standard | FAA | SOT-23 (Pb-Free) | 3000 / Tape & Reel |
| NCP4625HSN18T1G | 1.8 V | Standard | FAH | SOT-23 (Pb-Free) | 3000 / Tape & Reel |
| NCP4625HSN28T1G | 2.8 V | Standard | FAU | SOT-23 (Pb-Free) | 3000 / Tape & Reel |
| NCP4625HSN30T1G | 3.0 V | Standard | FAX | SOT-23 (Pb-Free) | 3000 / Tape & Reel |
| NCP4625HSN33T1G | 3.3 V | Standard | GAA | SOT-23 (Pb-Free) | 3000 / Tape & Reel |
| NCP4625HSN50T1G | 5.0 V | Standard | GAT | SOT-23 (Pb-Free) | 3000 / Tape & Reel |

†For information on tape and reel specifications, including part orientation and tape sizes, please refer to our Tape and Reel Packaging Specifications Brochure, BRD8011/D.

NCP4625

PACKAGE DIMENSIONS

SC-88A (SC-70-5/SOT-353)
 CASE 419A-02
 ISSUE K

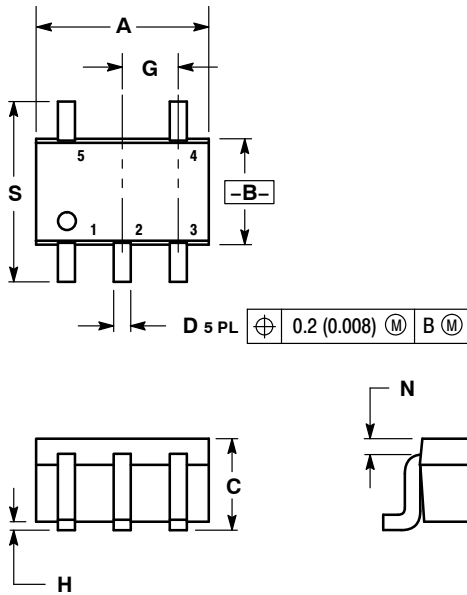

NOTES:

1. DIMENSIONING AND TOLERANCING PER ANSI Y14.5M, 1982.
2. CONTROLLING DIMENSION: INCH.
3. 419A-01 OBSOLETE. NEW STANDARD 419A-02.
4. DIMENSIONS A AND B DO NOT INCLUDE MOLD FLASH, PROTRUSIONS, OR GATE BURRS.

| DIM | INCHES | | MILLIMETERS | |
|-----|-----------|-------|-------------|------|
| | MIN | MAX | MIN | MAX |
| A | 0.071 | 0.087 | 1.80 | 2.20 |
| B | 0.045 | 0.053 | 1.15 | 1.35 |
| C | 0.031 | 0.043 | 0.80 | 1.10 |
| D | 0.004 | 0.012 | 0.10 | 0.30 |
| G | 0.026 BSC | | 0.65 BSC | |
| H | --- | 0.004 | --- | 0.10 |
| J | 0.004 | 0.010 | 0.10 | 0.25 |
| K | 0.004 | 0.012 | 0.10 | 0.30 |
| N | 0.008 REF | | 0.20 REF | |
| S | 0.079 | 0.087 | 2.00 | 2.20 |

NCP4625

PACKAGE DIMENSIONS

SOT-89, 5 LEAD
CASE 528AB-01
ISSUE O

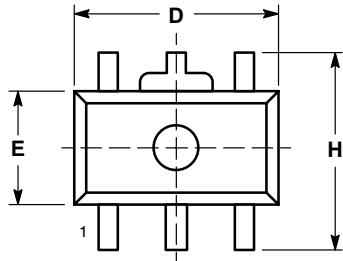

TOP VIEW

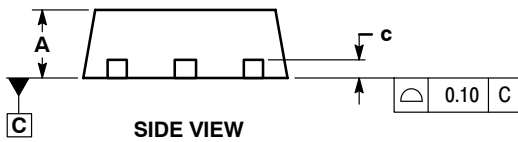

SIDE VIEW

NOTES:

1. DIMENSIONING AND TOLERANCING PER ASME Y14.5M, 1994.
2. CONTROLLING DIMENSION: MILLIMETERS.
3. LEAD THICKNESS INCLUDES LEAD FINISH.
4. DIMENSIONS D AND E DO NOT INCLUDE MOLD FLASH, PROTRUSIONS, OR GATE BURRS.
5. DIMENSIONS L, L2, L3, L4, L5, AND H ARE MEASURED AT DATUM PLANE C.

| DIM | MILLIMETERS | |
|-----|-------------|------|
| | MIN | MAX |
| A | 1.40 | 1.60 |
| b | 0.32 | 0.52 |
| b1 | 0.37 | 0.57 |
| c | 0.30 | 0.50 |
| D | 4.40 | 4.60 |
| D2 | 1.40 | 1.80 |
| E | 2.40 | 2.60 |
| e | 1.40 | 1.60 |
| H | 4.25 | 4.45 |
| L | 1.10 | 1.50 |
| L2 | 0.80 | 1.20 |
| L3 | 0.95 | 1.35 |
| L4 | 0.65 | 1.05 |
| L5 | 0.20 | 0.60 |

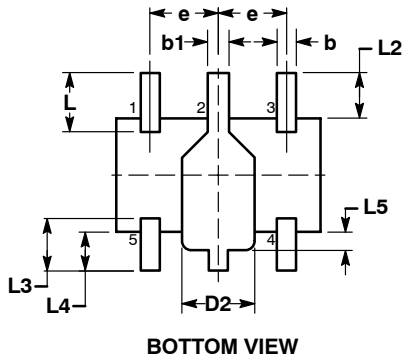

BOTTOM VIEW

RECOMMENDED MOUNTING FOOTPRINT*

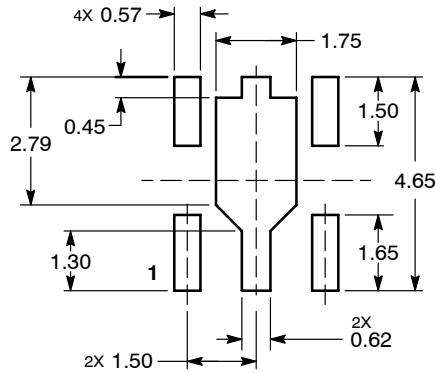

DIMENSIONS: MILLIMETERS

*For additional information on our Pb-Free strategy and soldering details, please download the ON Semiconductor Soldering and Mounting Techniques Reference Manual, SOLDERRM/D.

NCP4625

PACKAGE DIMENSIONS

SOT-23
CASE 1212-01
ISSUE O

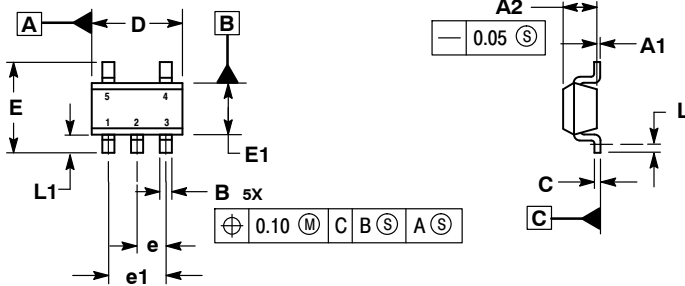

NOTES:

1. DIMENSIONS ARE IN MILLIMETERS.
2. INTERPRET DIMENSIONS AND TOLERANCES PER ASME Y14.5M, 1994.
3. DATUM C IS A SEATING PLANE.

| DIM | MILLIMETERS | |
|-----|-------------|------|
| | MIN | MAX |
| A1 | 0.00 | 0.10 |
| A2 | 1.00 | 1.30 |
| B | 0.30 | 0.50 |
| C | 0.10 | 0.25 |
| D | 2.80 | 3.00 |
| E | 2.50 | 3.10 |
| E1 | 1.50 | 1.80 |
| e | 0.95 BSC | |
| e1 | 1.90 BSC | |
| L | 0.20 | --- |
| L1 | 0.45 | 0.75 |

ON Semiconductor and  are registered trademarks of Semiconductor Components Industries, LLC (SCILLC). SCILLC reserves the right to make changes without further notice to any products herein. SCILLC makes no warranty, representation or guarantee regarding the suitability of its products for any particular purpose, nor does SCILLC assume any liability arising out of the application or use of any product or circuit, and specifically disclaims any and all liability, including without limitation special, consequential or incidental damages. "Typical" parameters which may be provided in SCILLC data sheets and/or specifications can and do vary in different applications and actual performance may vary over time. All operating parameters, including "Typicals" must be validated for each customer application by customer's technical experts. SCILLC does not convey any license under its patent rights nor the rights of others. SCILLC products are not designed, intended, or authorized for use as components in systems intended for surgical implant into the body, or other applications intended to support or sustain life, or for any other application in which the failure of the SCILLC product could create a situation where personal injury or death may occur. Should Buyer purchase or use SCILLC products for any such unintended or unauthorized application, Buyer shall indemnify and hold SCILLC and its officers, employees, subsidiaries, affiliates, and distributors harmless against all claims, costs, damages, and expenses, and reasonable attorney fees arising out of, directly or indirectly, any claim of personal injury or death associated with such unintended or unauthorized use, even if such claim alleges that SCILLC was negligent regarding the design or manufacture of the part. SCILLC is an Equal Opportunity/Affirmative Action Employer. This literature is subject to all applicable copyright laws and is not for resale in any manner.

PUBLICATION ORDERING INFORMATION

LITERATURE FULFILLMENT:
Literature Distribution Center for ON Semiconductor
P.O. Box 5163, Denver, Colorado 80217 USA
Phone: 303-675-2175 or 800-344-3860 Toll Free USA/Canada
Fax: 303-675-2176 or 800-344-3867 Toll Free USA/Canada
Email: orderlit@onsemi.com

N. American Technical Support: 800-282-9855 Toll Free
USA/Canada
Europe, Middle East and Africa Technical Support:
Phone: 421 33 790 2910
Japan Customer Focus Center
Phone: 81-3-5773-3850

ON Semiconductor Website: www.onsemi.com
Order Literature: <http://www.onsemi.com/orderlit>
For additional information, please contact your local Sales Representative